

SVI·605 SVI·605A

SUPER EXPANDER USER'S MANUAL

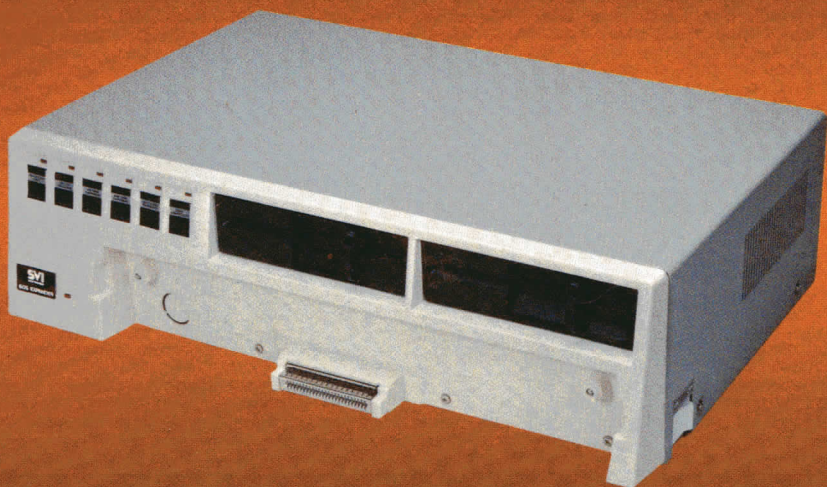

SVITM
SPECTRAVIDEO

SPECTRAVIDEO'S USER'S MANUAL STATEMENT

This equipment generates and uses radio frequency energy and if not installed and used properly, that is, in strict accordance with the manufacturer's instructions, may cause interference to radio and television reception. It has been type tested and found to comply with the limits for a Class B computing device in accordance with the specifications in Subpart J of Part 15 of FCC Rules, which are designed to provide reasonable protection against such interference in a residential installation. However, there is no guarantee that interference will not occur in a particular installation. If this equipment does cause interference to radio or television reception, which can be determined by turning equipment off and on, the user is encouraged to try to correct the interference by one or more of the following measures:

- Reorient the receiving antenna
- Relocate the computer with respect to the receiver
- Move the computer away from the receiver
- Plug the computer into a different outlet so that computer and receiver are on different branch circuits

If necessary, the user should consult the dealer or an experienced radio/television technician for additional suggestions. The user may find the following booklet prepared by the Federal Communications Commission helpful:

"How to Identify and Resolve Radio-TV Interference Problems"

This booklet is available from the U.S. Government Printing Office, Washington, DC20402. Stock No. 004-000-00345-4.

WARNING:

This equipment has been certified to comply with the limits for a class B computing device, pursuant of Subpart J of Part 15 of FCC Rules. Only peripherals (computer input/output devices, terminals, printers, etc.) certified to comply with the Class B limits may be attached to this computer. Operation with non-certified peripherals is likely to result in interference to radio and TV reception.

INTRODUCTION

Spectravideo's Expander Unit SVI-605 is specially designed to offer convenient and flexible expansion of the SVI-318/SVI-328MKII computer unit. The Expander unit connects directly to the system bus of the SVI-318/SVI-328 via a 50-pins connector. With the addition of the SVI-605, the SVI-318/SVI-328 can interface with a maximum of **4 different** peripheral devices and two floppy disk drives at one time. The metal casing of the SVI-605 which is helpful to eliminate EMI (electromagnetic interference) provides rigid and durable casing. Moreover, the most remarkable feature is the built-in floppy disk drive, disk drive controller and **centronics** interface in the Expander Unit. It is ready to utilize disk basic, **the** most current CP/M programme (with sufficient RAM installed) and hard copy printout with the addition of **Centronics** printer.

Before using the Expander Unit, please read this manual carefully.

SPECTRAVIDEO SUPER EXPANDER SVI-605/SVI-605A INSTRUCTION MANUAL

CONTENTS

	PAGE
1. Packing List	1
2. External View	2
3. Main Features	3
4. Installation	4
5. Operation	15
6. Diskette Handling	18
7. Cautions	19
8. I/O Assignment	20
9. Installation of the Optional Second Disk Drive	24
10. Specifications	26
11. Schematic Diagram	28
12. Servicing & Trouble shooting	29

1. Packing List

The SVI-605 package should contain the following items;

- (A) Expander Unit
- (B) SVI-605 User's Manual
- (C) CP/M Operating System Manual
- (D) CP/M Command Summary
- (E) CP/M User's Guide
- (F) CP/M 2.20 Diskette
- (G) Disk Basic User's Guide
- (H) SV Extended Basic Diskette
- (I) Six Peripheral indication Inlays
- (J) Labels sticker with words
- (K) Warranty registration card

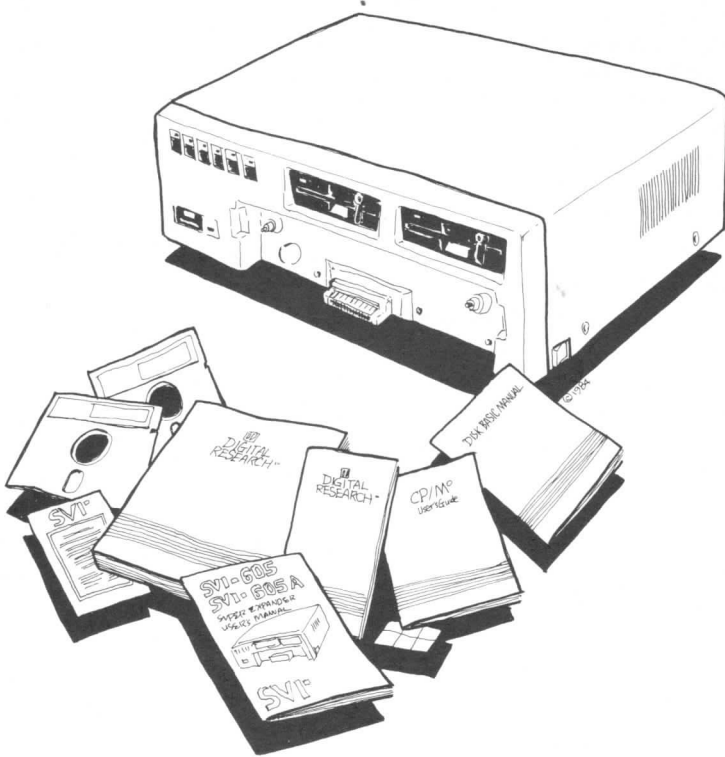

2. External View

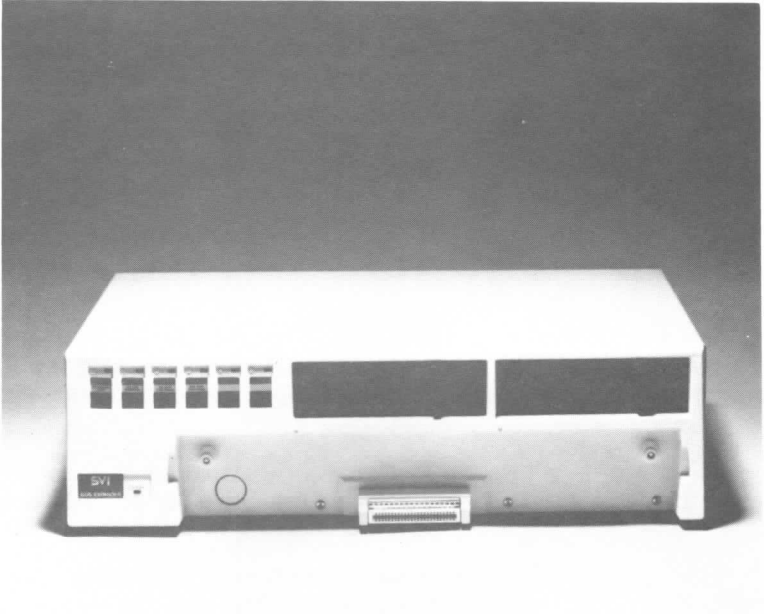

Note: Two installed disk drives for SV-605A

- 3. Main Features**
- (A) 4 slots to accommodate optional interface modules supplied in cartridge form.
 - (B) Convenient front panel read-out for selected add-on optional expansion and interface cartridges.
 - (C) Expansion cartridge power-on LED indication.
 - (D) Built-in half height 5¼" Disk Drive provides secondary memory capacity and high access speed.
 - (E) Provide power supply and protection circuitry to the built-in Floppy Disk Drive and the various optional expansion cartridges connected.
 - (F) Space available for installation of second optional Floppy Disk Drive for SVI-605 and two drives are installed in SVI-605A.
 - (G) Floppy Disk Controller Cartridge and Centronics Interface Cartridge are built in the circuit board.
 - (H) Special head surface for maximum signal transfer to and from diskette with minimum head/diskette wear.
 - (I) Stepping motor ensures precision positioning of the read/write head.
 - (J) Use industrial standard 5.25" flexible single sided, double density diskette.
 - (K) Fast access time: approximate 88 msec.
 - (L) Metal and sturdy housing capable of seating a 14" TV monitor (44 lbs/20 kg) provides good shielding to EMI.
 - (M) The front side of the SVI-605 Expander Unit is specially engineered to fit the rear side of the SVI-318 or SVI-328 computer unit.

4. Installation 4.1 Connections

(A) Connection between the SVI-318/SVI-328 computer unit and the SVI-605 Expander Unit is made via a 50-pins female edge connector.

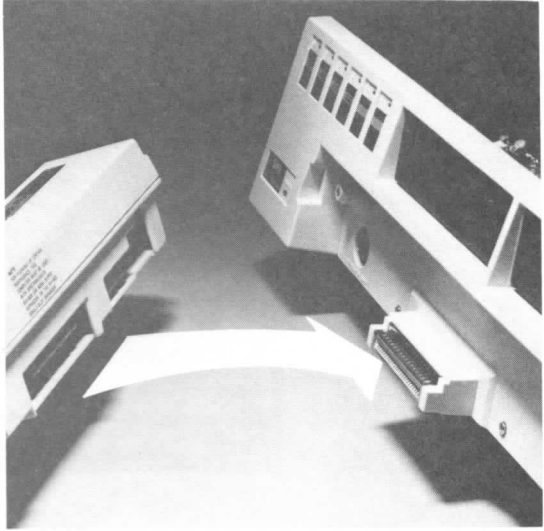

(B) The modulator or monitor cable is attached to the signal output ports at the back of the computer.

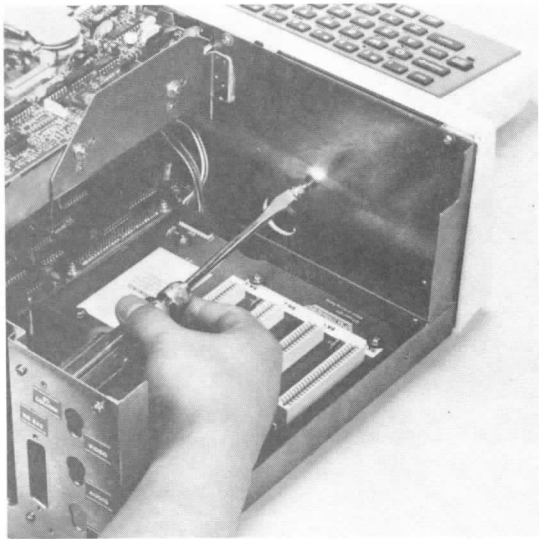

Remarks: After SVI-318/328MKII, is properly connected with the SVI-605 Super Expander, fix it well to the position with the mounting screws provided.

(C) Optional interface and expansion cartridges can be inserted in any of the 4 slots, from SK0 to SK3 (50-pins socket).

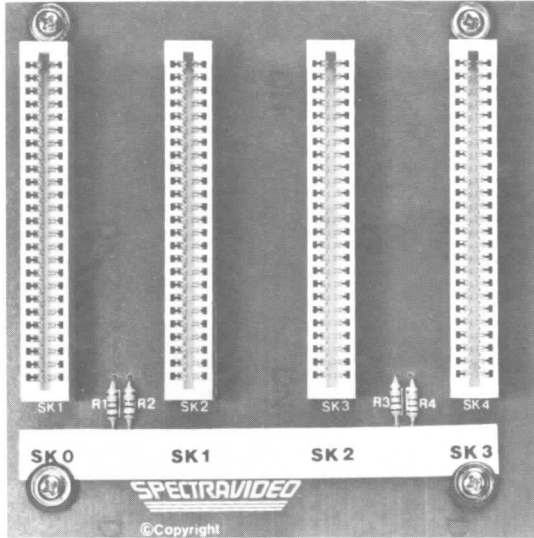

(D) You may install the transformer outside the Expander, cut the nylon band to remove it.

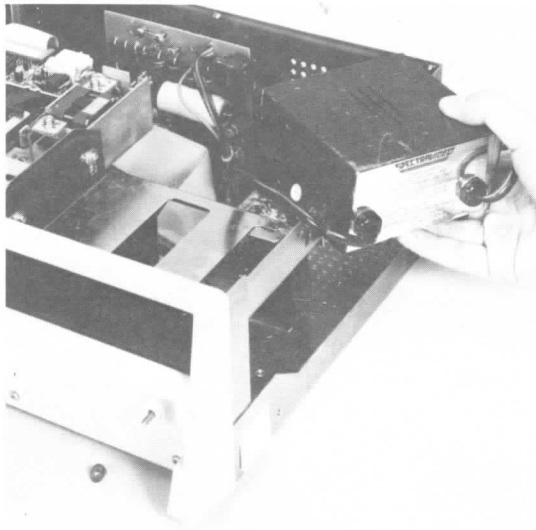

- (E) Dress the cable of the transformer through the hole at the rear panel of the Expander. Connect it to the socket on the power regulator circuit board which is located at the back panel of the Expander.

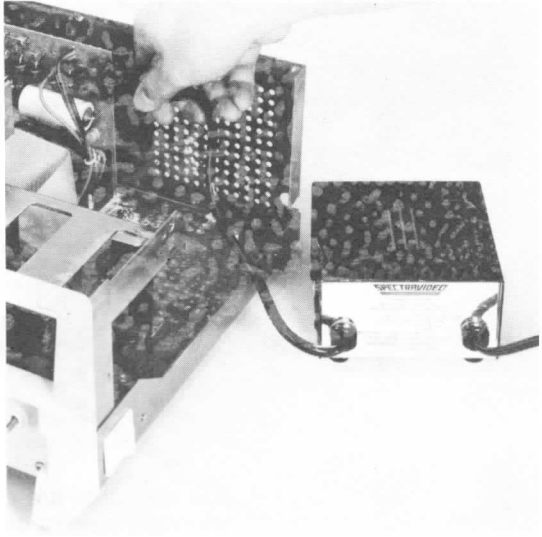

- (F) Connect the transformer to the AC power supply.

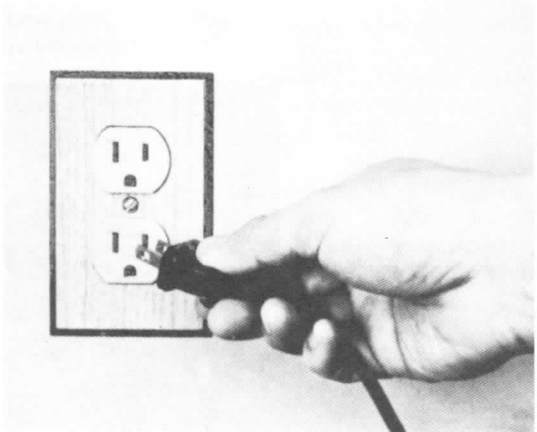

4.2 Installation of the optional peripheral interface

(A) Description of the rear panel of the Expander

1. There are 2 slots, 3 keyholes and 1 rectangular hole at the rear panel of the Expander.

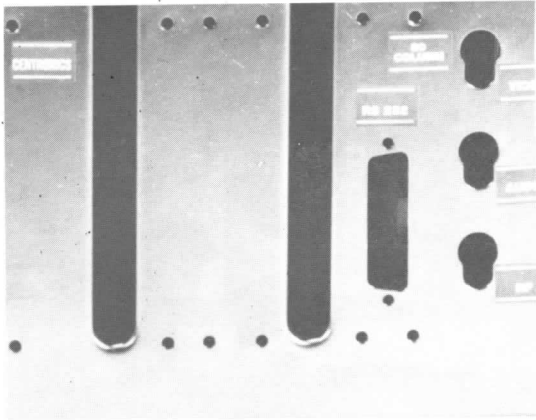

2. The two slots are designed to mount all flat interface cables while the rectangular hole is specially designed to mount the 25 pins D type socket for RS232. The three keyholes are designed for the monitor cable, RF cable as well as the 80 column cable.
3. Both two slots and the rectangular hole are shielded by the two metallic plates provided.

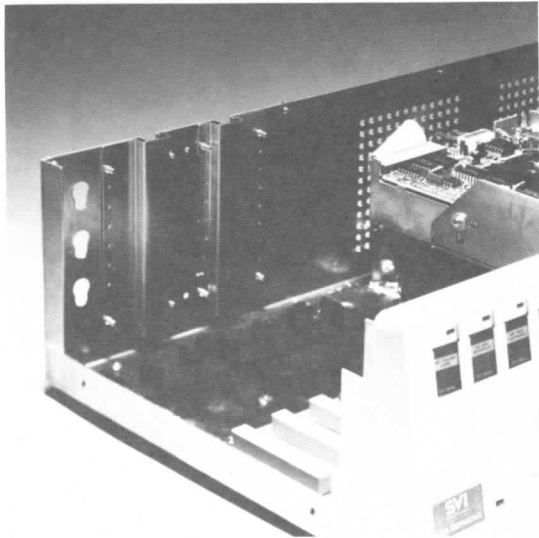

4. With one shielding plate turns up side down, the rectangular hole is not shielded. This allows you to install the connector of the RS232 cable to that position.

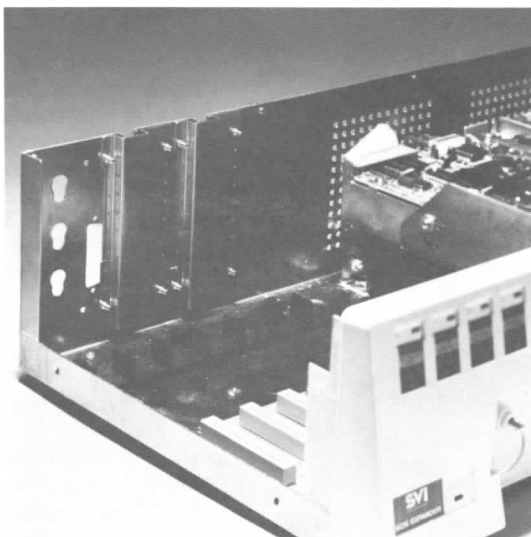

5. The shielding covers are designed to serve the following purposes:
 - a) good metallic contact to the shielding layer of flat cable to eliminate unwanted EMI.
 - b) acting as strain relief for the flat cable.
 - c) shielding of the RS232 port opening if it is not occupied.
6. Installation Recommendations
In general, RAM cards are recommended to be located at slots SK2, 3. Other peripherals may be located at slots SK0, 1 so that they are nearer to the panel opening.

(B) Monitor or Modulator Cable

Use a screw driver to remove the window plate which covers the front hole of the Expander Monitor cable for SVI-318/328

1. Attach the end of the cable connector to signal output ports at the back of the computer.
2. Dress the video and audio cables through the front hole of the Expander to the keyhole at the rear panel.
3. Connect the cables to the video and audio inputs of the monitor.

TV cable for SVI-318/328 Mark II

1. Plug the end of the cable connector to signal output port at the back of the computer.
2. Dress the cable through the front hole of the Expander to the keyhole at the rear panel.
3. Connect the cables to the input of the TV.

Modulator cable for SVI-318/328

1. Fix the modulator with double side tape at the location beside the slots.
2. Dress the modulator cable through the front hole of the Expander and attach the DIN plug to the RF port at the rear of the computer.
3. Connect one end of the TV cable to the RCA socket on the modulator and the other end to the TV through the rear panel of the Expander.

(C) Centronics Interface Cable

1. Remove the shielding plate at the back of the Expander.
2. Attach the connector of the SVI-205 Centronics Cable to the Centronics printer interface port and dress the cable through the slot.
3. Replace the shielding plate and fix it to the position with the screws provided so that the shielding layer of the cable makes good contact with the rear chassis. (For good EMI shielding, shielded cable is recommended.)

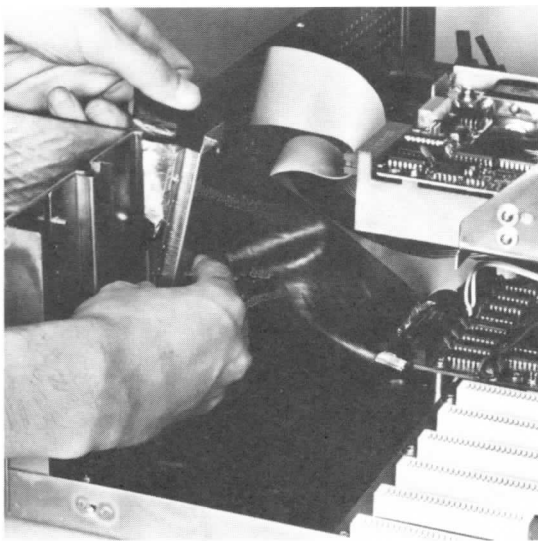

4. Connect the other end of the cable to a Centronics Printer or the SVI-901 Dot Matrix Printer.
5. Connect the power cable of the printer to the AC power supply.

(D) SVI-805 RS232 Interface Cartridge

1. Insert the card in any of the 4 slots from SK0 to SK3.
2. Remove the shielding plate which covers the RS232 port at the rear of the Expander.
3. Fix the socket of the RS232 cable to the port with screws.
4. Turn the shielding plate up side down and fix it back to position with the screws provided such that the RS232 port is not blocked.
5. Use a standard RS232 shielded cable to connect the data communication equipment to the Expander Unit.

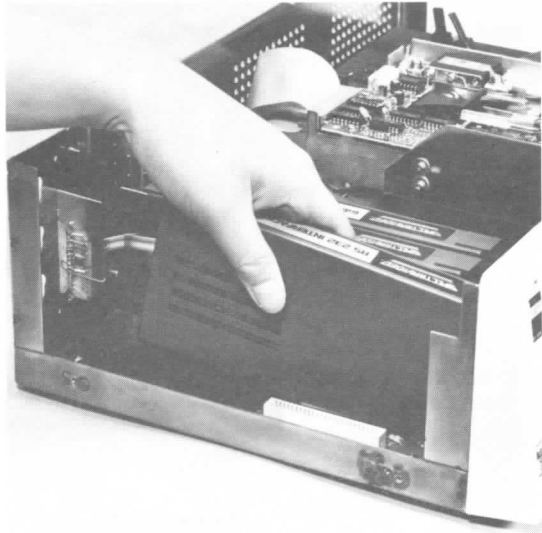

(E) SVI-806 80 Column Video Board Cartridge

1. Insert the card into any of the 4 slots gently.
2. Dress the cable through the keyhole on the rear panel of the Expander.
3. Press the RCA phono connector down and fix it to the position. Fasten the mounting ring.
4. Attach one end of the phono cable to the connector and the other end to the monitor.



(F) SVI-803/SVI-807 16K/64K RAM Cartridge

1. Insert the card into any of the 4 slots gently.
2. The SVI-803 fills the first half of Bank 0 Page 2 in the SVI-318 computer unit.
3. The SVI-807 is designed to fill in the memory banks of the SVI-318/SVI-328 computer units with the use of DIP switches.

Switch	Bank/Page
S1	21
S2	22
S3	31
S4	32
S5	02
S6	48K/32K

Bank Memory for SVI-318

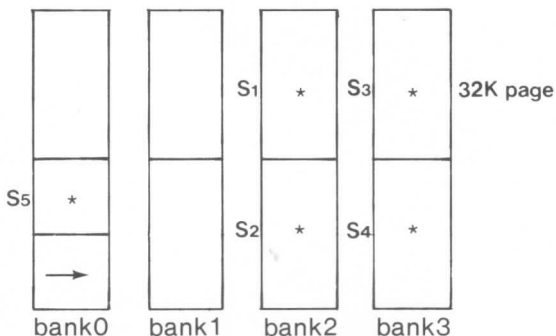

* RAM: the user expandable RAM area
 → RAM: the built-in RAM area
 Total : there are 144K user expandable RAM area.

Bank Memory for SVI-328

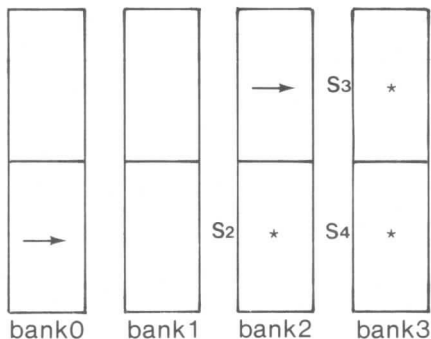

* RAM: the user expandable RAM area

→ RAM: the built-in RAM area

Total : there are 96K user expandable
and 64K built-in RAM

Remark: Prefer to put SVI-803/807
RAM cartridge into slots SK2, 3.

For details, please refer to the corresponding
User Manual.

After the ports of the Expander Unit are
assigned, remove the sticker labels from the
label sheet and fix them to the appropriate
locations at the rear panel.

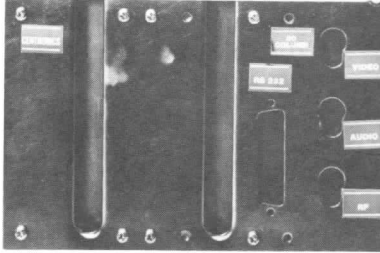

After plugging in the cartridge, replace the top
cover on to the Expander Unit. Put the
appropriate label plate of the cartridge on the
corresponding notch of the Expander such that
the correct LED indicator can be lighted when
power is switched on. The label plates of the
Centronics Interface and Disk Drive Controller
are already inserted to the appropriate notches.

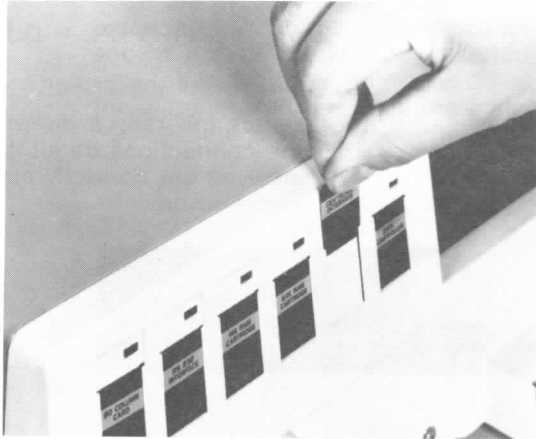

Note: Users are recommended to use shielded
cables and sockets for connection
between SVI-605 super expander and
external devices in order to minimize
the effect of electromagnetic
interference.

5. Operations

(A) Operations of the Cartridges

1. Connect the SVI-605 to the SVI-318 or SVI-328 before turning on power.
2. Never switch on the power until all connections are properly made.
3. Switch on the power. The power-on LED indicator will illuminate.
4. All operations of interface cartridges and associated peripherals are controlled by the host computer SVI-318 or SVI-328 MKII. For details to the individual interface cartridges manuals.

(B) Operation of the Centronics Printer with SVI-605 Super Expander

1. Under Disk Basic

To print a file, load the programme and then "LLIST" it on the paper. The following commands are used.

```
LOAD "<disk drive#> : <filename>"
```

```
ENTER
```

```
e.g. LOAD "1 : TEST" ENTER
```

```
OK
```

```
LLIST ENTER
```

The programme will be listed on the paper.

2. Under CP/M

If you want to print a file, just enter the following statement, the computer will do it for you.

```
<disk drive #> > PIP PRN: = <filename>
```

```
ENTER
```

```
e.g. B > PIP PRN: = DUMPASM ENTER
```

(C) Operation of the diskette

1. Before inserting a diskette, make sure that the connections on all the appliances involved are correctly made and power is switched on.

2. Move the disk lock to the horizontal position. Remove the card which protects the read/write head during transportation in the disk drive.

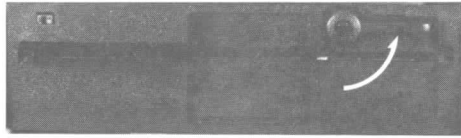

3. With the diskette label facing up and the head window towards the slot, insert the diskette into the slot.

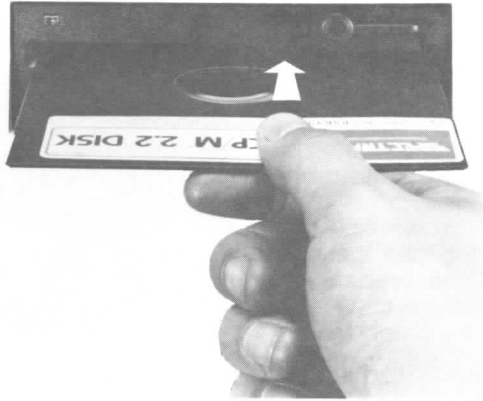

4. Push the diskette lightly until it stops and move the lock to the vertical position as shown. If the diskette is not inserted all the way, the lock cannot be moved down. When this happens, do not force the lock but re-insert the diskette correctly.

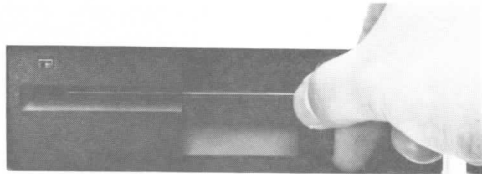

5. All reading and writing of data is controlled by the host system SVI-318/328. For details refer to the software manual. A maximum of 2 drives can be operated in the same computer system.
6. Removal of Diskette
 - a) With the power switched on, move the disk lock to the horizontal position.
 - b) Make sure the in-use LED indicator is off before removing a diskette.
 - c) Hold the label of the diskette and take the diskette out from the slot carefully.



7. Write-protection Notch
 - a) If the write-protection notch of the diskette is covered by a paper seal, etc; writing of data is forbidden. Reading however is possible.
 - b) Do not cover the notch of a new diskette you plan to use with any type of seal, or writing will be impossible.



6. Diskette Handling

- (A) Do not touch, soil or scratch the recording surface (head window) of the diskette with your finger. It is not necessary to turn a diskette in its jacket, this will be done by the disk drive.
- (B) Do not bend or fold the diskette or it will become unusable.
- (C) Keep diskettes away from magnetic fields (motor, telephone, etc.) and from ferromagnetic materials which might become magnetized. Strong magnetic fields can distort recorded data on disk.
- (D) Do not write on the identification label with lead pencil or ball point pen. Use felt tip pen. Do not use erasers.
- (E) When a diskette is not in use, put it in an envelope and file it away. Replace storage envelopes when worn, cracked or distorted. Envelopes are designed to protect disk.
- (F) Storage temperature of the diskette is 4 – 50°C. Do not put it in direct sunlight or where the temperature rises above 50°C. The jacket will be unusable. Dust it with a soft brush if necessary.

7. Cautions

- (A) The computer and the expander must be placed on the same table level to ensure the good contact of the edge connector between the two devices.
- (B) Moving either the computer or the expander when power is on may cause short circuit of the connector bus and eventually the computer and peripheral interface modules can be burnt.
- (C) Connect the expander power supply only to the rating voltage specified on the power transformer.
- (D) Never install or use the expander in the following environment:
 - where it is heated by direct sun light.
 - where there is moisture.
 - where there is vibration.
- (E) All ventilation holes of the expander and computer must not be blocked to improve heat dissipation.
- (F) Never insert or remove interface cartridge into/out of the expander when power is on.

For better safety, it is recommended that the power is switched off for 3 sec before interface cartridge is inserted or removed from the expander.

8. I/O Assignment

PIN	NAME		PIN	NAME
1	+5V		2	+5V
3	+12V		4	-12V
5	GND		6	WAIT
7	RST		8	CPU CLK
9	A15		10	A14
11	A13		12	A12
13	A11		14	A10
15	A9		16	A8
17	A7		18	A6
19	A5		20	A4
21	A3		22	A2
23	A1		24	A0
25	RFSH		26	GND
27	M1		28	GND
29	WR		30	MREQ
31	IORQ		32	RD
33	D0		34	D1
35	D2		36	D3
37	D4		38	D5
39	D6		40	D7
41	CSOUND		42	INT
43	RAMDIS		44	ROMDIS
45	BK32		46	BK31
47	BK22		48	BK21
49	GND		50	GND

Disk Drive Interface Signals

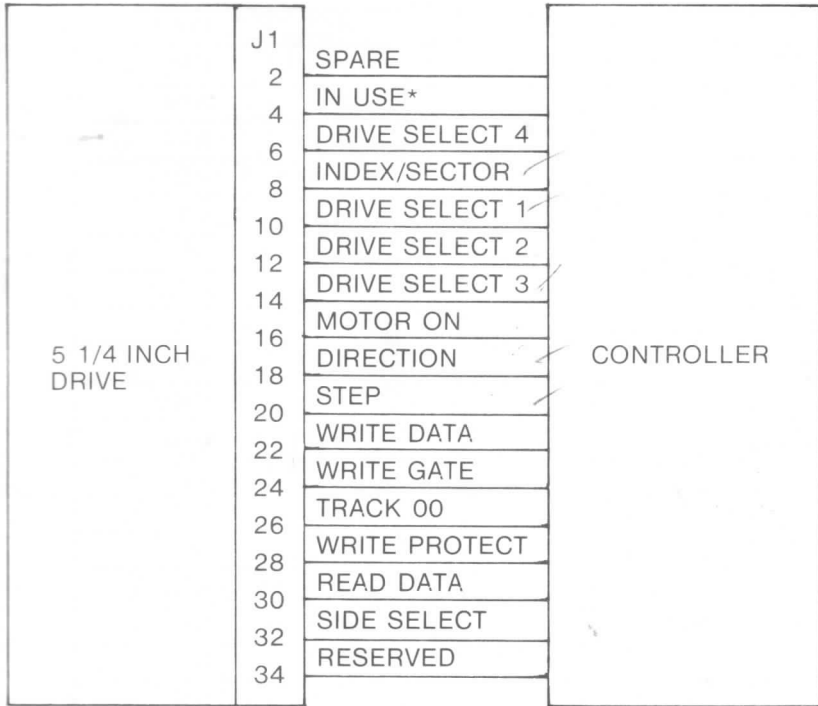

ODD PINS RETURN (DC GROUND)

POWER

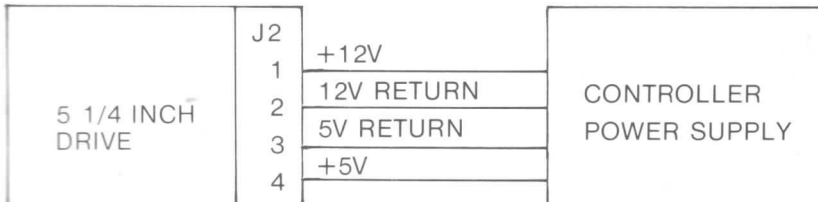

SVI-605/605A BUS SIGNAL DESCRIPTION

PIN:	NAME:	I/O:	DESCRIPTION:
1,2	+5V	O	+5V power supply, 1A current is available for all peripheral cards.
3	+12V	O	+12V power supply. Maximum current is 800mA for all peripheral cards.
4	-12V	O	-12V power supply. Maximum current is 50mA for all peripheral cards.
5	GND		System electrically ground.
6	WAIT	I	Indicates to Z80A CPU that the addressed memory or I/O devices are not ready for data transfer.
7	RST	I	When this signal is pulled LOW the system begins a RESET cycle.
8	CPUCLK	O	Buffered system clock of frequency 3.58 MHz.
9-24	A15-A0	I/O	Buffered ADDRESS BUS. This is a 16-bit address bus providing addresses for memory data exchange and I/O device data exchange.
25	RFSH	O	Buffered REFRESH signal for the dynamic RAM expanders only. This signal indicates that the lower 7 bits of the address bus contain a refresh address for the dynamic RAM.
26	GND		System electrically ground.
27	M1	O	Buffered MACHNINE ONE CYCLE signal. This signal indicates that OP code fetch cycle is the current machine cycle.
28	GND		System electrically ground.
29	WR	O	Buffered WRITE signal. This signal indicates that the CPU data bus holds valid data for storage in the addressed memory or I/O device.
30	MREQ	O	Buffered MEMORY REQUEST signal. This signal indicates when the address bus is holding a valid memory address.
31	IORQ	O	Buffered INPUT/OUTPUT REQUEST signal. This signal indicates the lower 8 bits of the address bus are holding a valid I/O device address, and is at HIGH state (i.e. inactive) during the INTERRUPT cycle.
32	RD	O	Buffered READ signal. This signal indicates that the Z80A CPU wants to read data from memory or an I/O device.
33-40	D0-D7	I/O	Buffered bidirectional DATA bus. This is an 8-bit bidirectional data bus for data exchange between memory and I/O devices.

41	CSOUND	I	Audio input
42	$\overline{\text{INT}}$	I	Generated by I/O devices to request interrupt to Z80A CPU.
43	$\overline{\text{RAMDIS}}$	I	Pulling this signal LOW disables the SVI-318/328 user RAM. This line is held high by a 1K ohm resistor to +5V.
44	$\overline{\text{ROMDIS}}$	I	Pulling this signal LOW disables the SVI-318/328 BASIC ROM on board.
45	$\overline{\text{BK32}}$	O	Buffered MEMORY BANK CONTROL signal. This signal LOW enables the bank 32 portion of the memory (32K, Addr. — 8000H-FFFFH), and disables the user RAM on board through the RAMDIS signal.
46	$\overline{\text{BK31}}$	O	Buffered MEMORY BANK CONTROL signal. This signal LOW enables the bank 31 portion of the memory (32K, Addr. — 0000H-7FFFH), and disables the BASIC ROM on board through the ROMDIS signal.
47	$\overline{\text{BK22}}$	O	Buffered MEMORY BANK CONTROL signal. This signal LOW enables the bank 22 portion of the memory (32K, Addr.— 8000H-FFFFH), and disables the user RAM on board through the RAMDIS signal.
48	$\overline{\text{BK21}}$	O	Buffered MEMORY BANK CONTROL signal. This signal LOW enables the bank 21 portion of the memory (32K, Addr.— 0000H-7FFFH) which is the lower portion of SVI-328 user addressable memory, and disables the BASIC ROM on board.
49-50	GND		System electrically ground.

9. Installation of the optional disk drive B

- (A) In the SVI-605 Super Expander Unit, there is a space available for the installation of another floppy disk drive SVI905. It is located next to the built-in disk drive at the top right hand corner.
- (B) Just remove the top cover and unfasten the two screws at the front panel of the second disk drive compartment. Insert horizontally the disk drive that you bought into the compartment.

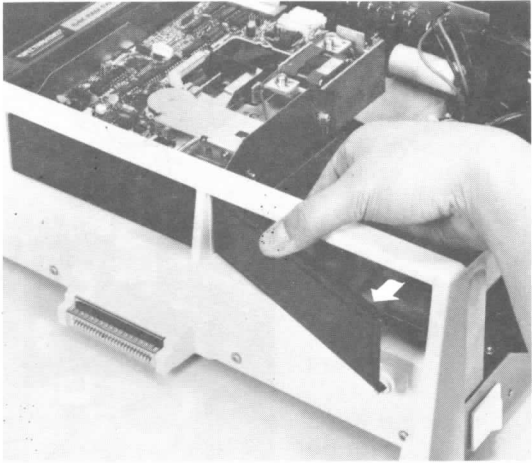

- (C) Fix it well on the position with the mounting screws which are taken out from the front panel cover. Then connect the power supply and disk drive control cable. Pay attention to the polarity of the two connectors.

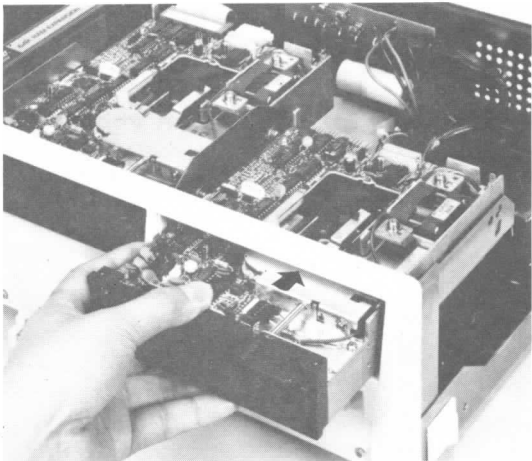

- (D) Make sure only one terminator is located in one of the two disk drives at most and the Disk Drive Assignment Selection Plug is inserted to the appropriate pin-socket on the disk drive.

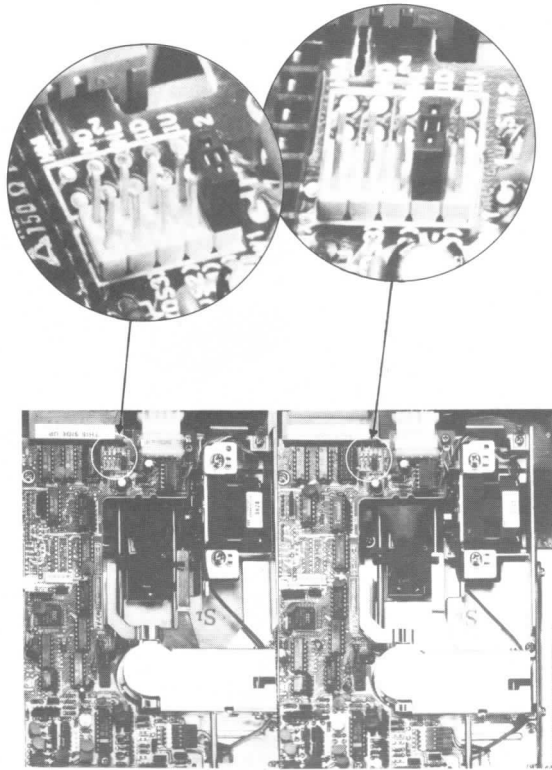

10. Specifications

Specifications and product appearance are subject to change without notice.

(A) Specification of the floppy disk drive

Drive Unit	Single
Diskette	Uses 5¼" single-sided double-density floppy diskette, the industrial standard (oxide on 0.003 in mylar)

(B) Specification of disk format:-

MEMORY CAPACITY

Unformatted	250K Byte per diskette
Formatted	172K Byte per diskette

BASIC FORMAT

Bytes/Sectors	Track 0 128 Track 1-39 256
Sectors/Track	Track 0 18 Track 1-39 17

Recording Method	FM/MFM
-------------------------	--------

Packing Density	5536 bpi
Track Density	48 tpi

Data Transfer Speed	250K bits/sec
----------------------------	---------------

Average Access Time	88 msec
----------------------------	---------

Motor Starting Time	500 sec
----------------------------	---------

Spindle Speed	300 rpm
----------------------	---------

Operating Temperature	5°C to 45°C
------------------------------	-------------

Operating Humidity	20% to 80%
---------------------------	------------

Power Requirement	Power supplied by SVI-605 Super Expander
--------------------------	--

(C) Other general specifications
Built-in floppy disk controller for 2 drives,
single disk drive for SVI-605 (second drive
optional), dual disk drives for SVI-605A, and
parallel (Centronics compatible) printer
interface.

Slots	Four sockets for optional interface cartridges
Input	One 50-pin socket to the SpectraVideo System Bus
Power Requirements	115V 60Hz 200V 50Hz 240V 50Hz
Optional Interfaces And Expansion	SVI-803 16K RAM Cartridge SVI-805 RS232 Interface SVI-806 80 Column Cartridge SVI-807 64K RAM Cartridge SVI-901 Dot Matrix Printer
Dimensions (mm)	490 (W) x 280 (D) x 130 (H)
Weight	Approximately 7.5 Kg

11. Schematic Diagram

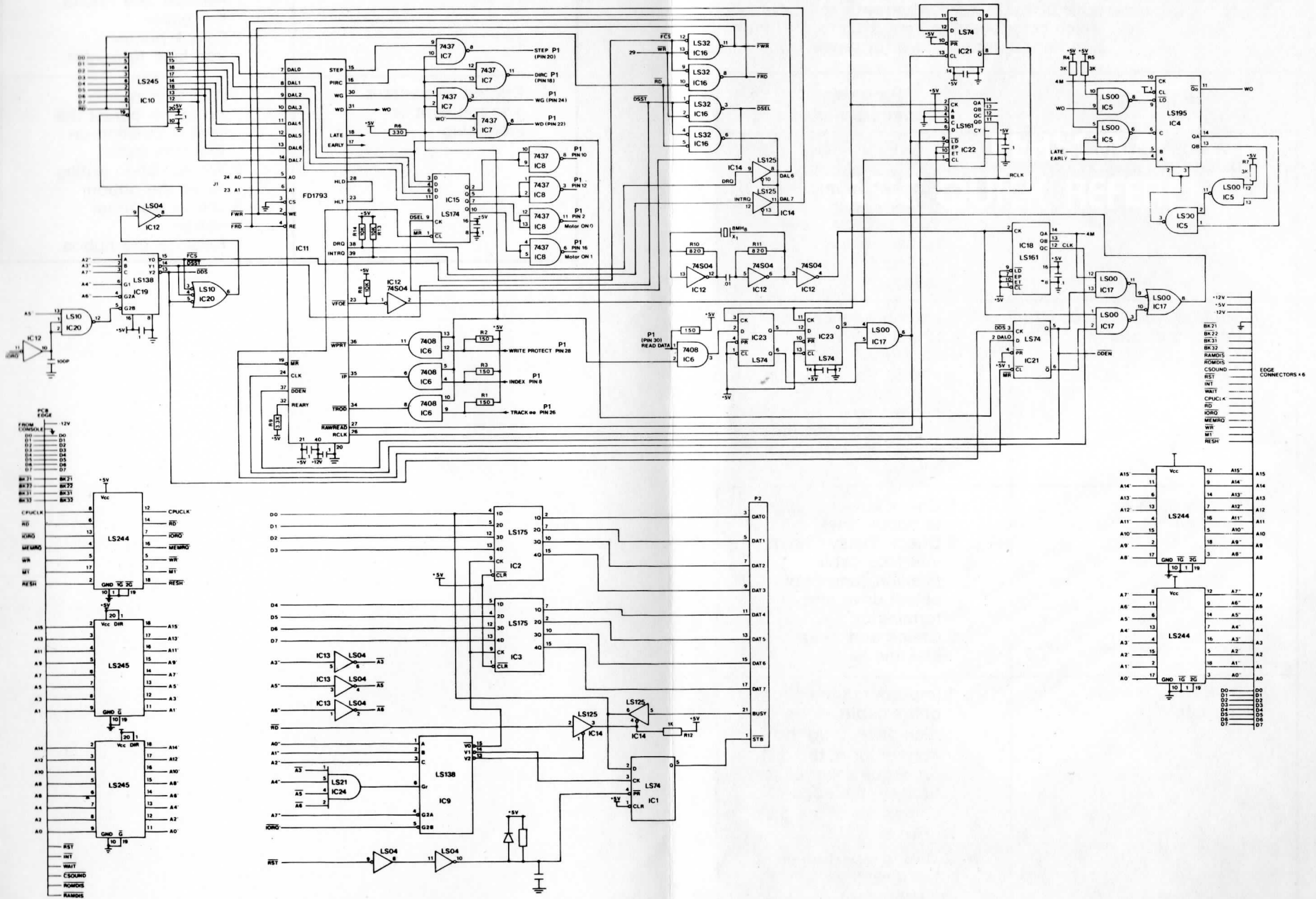

12. Service and Trouble Shooting

We hope you don't have problems but just in case ... see if you can solve them by using the table below. If you can't, they try to determine which component in your system is at fault, and bring it into a store for repair.

Problem	Probable Causes/Solutions
SVI-605 won't function Power Indicator 'OFF'	<ol style="list-style-type: none">1. Expander power is 'OFF'. Check the connection and the power switch.2. Fuse may be blown. Replaced only with a fuse of the same rating.
SVI-605 won't function Power Indicator 'ON'	<ol style="list-style-type: none">1. Improper connection Check the wiring of all interface cable to interface cartridge.2. Bad system bus connection. Adjust and refix the SVI-318/328MKII to SVI-605.
Floppy drive no function	<ol style="list-style-type: none">1. Check power supply to floppy drive.2. Check 'Daisy Chain' interface cable position, jumper of select drive and terminator.3. Check and swap disk media.
Disk Drive B won't function	<ol style="list-style-type: none">1. Improper connection of the cable to the disk drive. Plug the connector of the disk drive controller cable firmly to the edge connector of the disk drive B.2. Wrong insertion of the disk drive assignment selection plug. The plug should be inserted to the DS1

	pinsocket of drive B.
Printer no function	<ol style="list-style-type: none">1.Paper is jammed remove and reload the paper.2.Check printer interface to printer.
Printed characters are too light or smudging	<ol style="list-style-type: none">1.Improper printer pressure, adjust the lever's position on the print head.2.Wrong ribbon setting reset the ribbon3.Old or worn-out ribbon Replace the ribbon.

SVITM
SPECTRAVIDEO

PRINTED IN HONG KONG

SVI-605-UM

© 1984 SPECTRAVIDEO INTERNATIONAL LTD.